

On The LIGHTER Side

September 15, 2012

Vol. XXIXI, No. 5

And Now A Letter From Your Editor Richard Weinstein

As we enter the last quarter of 2012, we need to decide how much we want this club to continue. As you are all aware, Judith has decided to step down from the day to day operations of the club. Her wishes are to continue being a regular member and would like to continue working only on the conventions. That means we need members to step up and help make the club a continued success. That means doing more than just paying dues. The articles are what keeps the newsletter fresh and interesting. Without the articles, what is the point of the newsletter? We do not need a newsletter to let you know just when the next show is. The newsletter is there to help members learn about what they might be curious about but never knew.

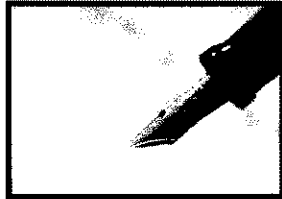

See Bob Gamboni's great new finds. See George Gynes interesting Ronson article. When was the last time you did not see an article by John Cornelius! How about the great work by Art Brooks to bring you information about lighters he has never even seen! Art wrote an article in this newsletter asking help from anyone who might have the lighter he just wrote about! These are the names of the members of the club who take the time to share which is what a club is all about. I know most of you have gone to flea markets and antique shows and found something you never saw before. Well, if you haven't seen it, maybe other's have not either. I am sure they would like to know about it. How about Urban's RTL article! If he didn't write this, no one would ever know the lighter existed!

We have many Zippo members out there. How many of you have found a great Zippo that others might love to see! Not every lighter is bought on eBay. There are always nice articles in the PLPG

newsletter with great Zippo finds. I am sure we have many Zippo members as well who could take the time to help out. How about someone who sits on eBay all day seeing interesting lighters for sale create a file of these interesting finds and make an article out of it.

The few members mentioned above are not here to keep the club going. These members work just like many of us. If they can take the time, so can you. No board member makes a dime off the club. They do it to keep the club going. Many hours are spent researching possible locations for conventions. Other than a small minute fee to Judith for her time which in many instances she does not even accept when things are tight, not one penny goes to anyone else. Anyone feel bad now for not helping! Don't feel bad, help!

My Recent Finds

by Bob Gamboni

Here are photos of some of my recent acquisitions I've not seen elsewhere that I thought the membership would like to see. The lighter with the bear is marked D.R.G.M. indicating it was produced in Germany. I think the bear is a symbol of the city of Berlin. The blue enameled lighter is marked 'Everest' and is sterling with enamel on

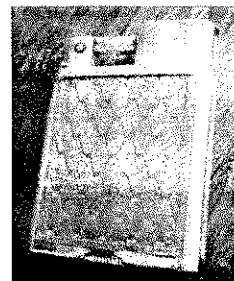

EVEREST



D.R.M.G.

four sides; a beautiful lighter. I like the WWI trench lighter for its overall design, especially the unusual wick snuffer. The piece in the form of the head of Gobbo is an incense burner produced by Ronson. As you can see, it says I Am

(Continued on Page 2)



TRENCH LIGHTER

Gobbo The God Of Good Luck'. If you are a Ronson collector, you've got to have one of these to help in the finding of good Ronsons for your collection. The



GOBBO

Ronson lighter with the image of Queen Elizabeth may be common in London, but I've not seen one before, and I do a lot of looking around. This is a butane lighter,



QUEEN ELIZABETH

one I was happy to find. The Evans lighter with the blue enamel I've actually had for a while. I'm including it here with my more recent finds because Terry

Post recently informed me that a Roller Bearing with a gold plated finish and engraved ears is extremely rare, something I didn't realize before. I love Elgin-Otis lighters, so I was delighted to find the set shown here. It has an unusual oriental design. I found the Koopman's cap lighter recently at a local flea



EVANS

market. I was very happy with this find because it is a rare two-

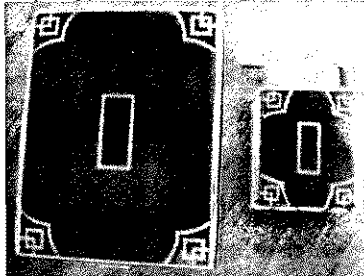

ELGIN-OTIS

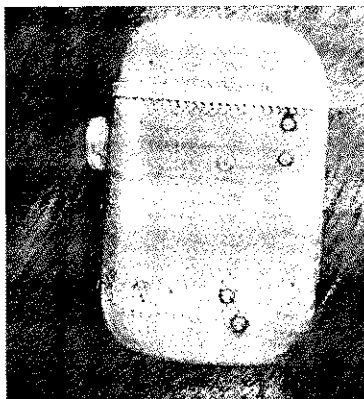

KOOPSMAN

button Koopman's and has a finish I have not seen before.

Last, but not least, is the Scripto with the wonderful image of the winged head of Mercury. As a final comment here, I'm glad I collect all types of lighters because I'm able to experience the 'joy of the find' much more often than I otherwise would. Good hunting!

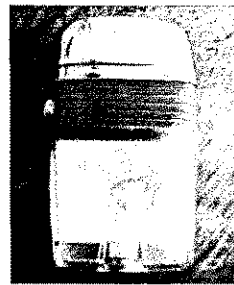

SCRIPTO

U.S. NAVY SEABEES 62ND BATTALION

Contributed by Tom Jones

This is one of the most beautiful unlit 1967 Zippo I've seen. It consists of 8 colors, which are white, blue, red, black, yellow, orange, OD green and brown.

The 62nd Battalion arrived in Vietnam 8 December 1966. They departed Vietnam 13 November 1970. The number of teams deployed: 6. Each battalion consisted of 24 officers and 738 enlisted. Navy Seabees were used to build waterfront facilities, containments, storage areas, ammunition dumps, roads, and bridges. They were based in Da Nang, Chu Lai, Hue-Phu Bai Dong Tam and Quang Tri.

Reference source: Vietnam Order of Battle by Shelby L. Stanton, Caption U.S. Army, retired

(see photo below)

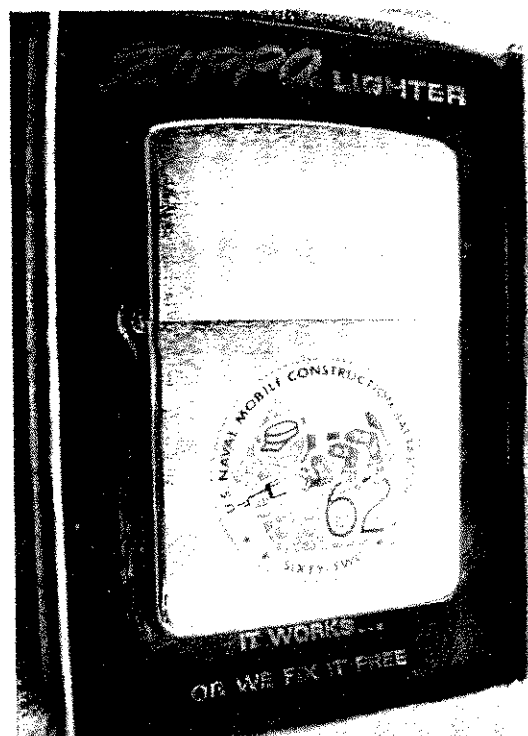

Stratoflame Compressed Fuel Lighter - c. 1950

Source: John Cornelius

The Stratoflame was a product of the Stratford Pen Corporation of New York, which like Parker, apparently saw opportunity in expanding into the lighter business. The company, founded in the early 1900's by three brothers, was originally named Salz Brothers and renamed sometime in the 1940's. Primarily known for manufacturing low to medium quality fountain pens and appears to have remained in business into the mid-late 1950's. The 15 story Salz building, erected in 1910, still remains in New York.

The Stratoflame was designed by Charles Metzler and Bill Bowen in 1949 and US Patent number 2,551,688 was granted in May 1951. The lighter features a significant degree of retro-deco styling with a relatively simple mechanical approach incorporating a butane canister or "flask" as it was referred to by the designers. The lighters were sold with flasks containing butane fitted for refueling the lighter and advertised in finishes including chromium, gold plate, solid gold, sterling silver, and enamel. Original prices were Chromium - \$9.95 and Gold Plate - \$15.00. I have never seen one in either solid gold or sterling silver, but will look more closely in the future.

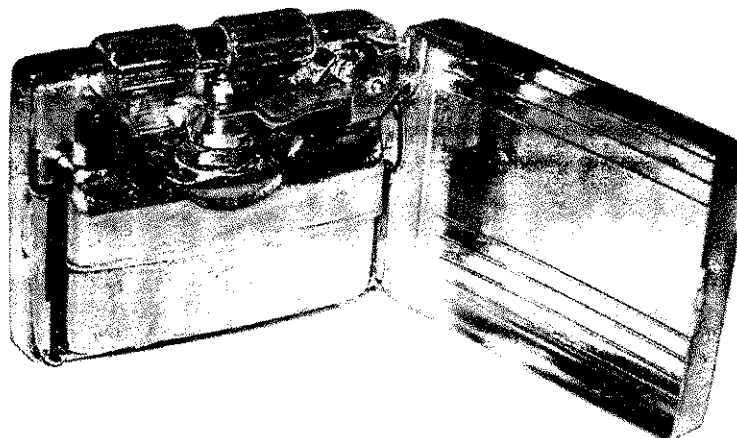
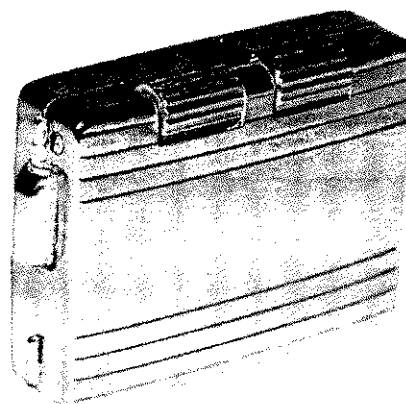

THE Zippo® LINK

by Amber Bacha

500 Millionth Zippo Lighter Takes its Place in History

The 500 millionth Zippo lighter came off the metal press at 8:26 a.m. on Tuesday, June 5th, 2012, the birthday of the late Zippo founder George G. Blaisdell. Just a few short hours later, the case was stamped with the exact time it was finished, 10:51 a.m. The 500 Millionth Zippo lighter was then passed hand to hand, in two pieces — the lighters brushed chrome-plated

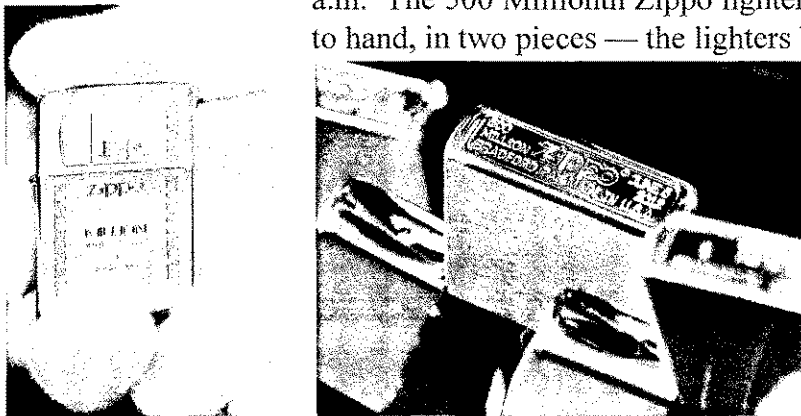

brass case and its fuel-and-wick assembly innards — by each of the company's 620 employees, who were lined up between the Zippo plant and the Zippo/Case Museum a few hundred yards away.

The final two Zippo employees to touch this special lighter were the most tenured employee Barb Reid, 47 years of service, and A.J. Comilla, who has 18 years of perfect attendance at Zippo. Reid and Comilla then handed the two pieces to Zippo President Greg Booth. Booth then assembled the two pieces and presented the 500 millionth Zippo lighter to Zippo Owner George Duke. Duke then toasted the crowd of employees, retirees and media and then chaperoned the 500 millionth lighter into its place in Zippo history, forever enshrined at the Zippo/Case Museum.

Here's to the next million Zippo Lighters!!

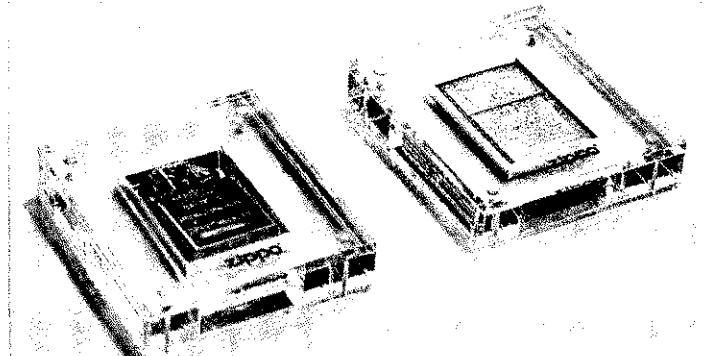
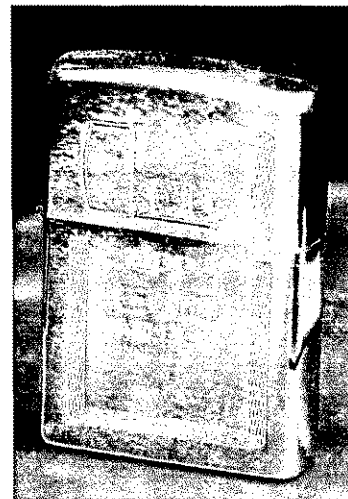

THE STORY OF THE "RTL"

Just about the time you thought you'd seen the very last unknown Ronson — here comes another. Our thanks go to your faithful editor, Sir Richie Weinstein, who brought it to Vegas. We guessed it must be Ronson's Tiniest Lighter so we therefore named it the "RTL". See Photo #1. It's about 1 inch wide by ½ inches high, top to bottom with a bright red leather wrap. Photo #2 shows the bottom plate.

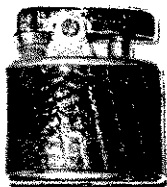

FIG. 1

It took a while to sink-in, but I finally realized it looks like a shortened version of the Pet, Fig. 32, Ronson book. Next, look at Photo #3. Adjacent to the Pet on the far left is the fitment taken from the Smart Set, Fig. 76. Guess what? It's exactly the same size as the RTL. So

Photo #2



ART METAL WORKS

U.S. PAT. 2,916,551

Photo #3



often did, used something already in production, to create a new model lighter. That explains the RTL. Photo #4 shows it, far left, with a Venus, Fig. 63, next to it followed by a Junior, Fig. 16 and a Princess, Fig. 17 on the far right. Very, very cool, eh?

this wonderful new find is not unique after all. It's just a different version of what they already made. The Cadet Mini on the far right is shown for comparison.

So, Ronson, as they



Photo #4

One final comment. All of the above just goes to prove what we've been saying all along: you want to find a great lighter? -- Come to our Annual Convention.

'Nuf said.

Urban Cummings

My Latest Flame

by George Gynes

Some Striking Strikers

Some years ago, before "Political Correctness" took control of our lives, I had a secretary who had a file labeled "Questionable Characters". That is where she would file some of the job applicant's résumés. I am certain that if the characters of some of these lighters had showed up in front of

her desk, their paperwork would have made it into that category. However, as a collector of unusual lighters I have certainly enjoyed each.



The first one was created in 1915 and depicts the Cartoon Characters Mutt & Jeff. They were an American newspaper Comic Strip created by Bud Fisher in



of booze sitting on the table. (a clever trick later used by Ronson to hide the striker on the Bartender Touch Tip & Striker lighters.) The caption on the base reads, "This is the Life - Fisher" (for Bud Fisher the creator of the characters). The table has the quote written on it: "1915 Boost".

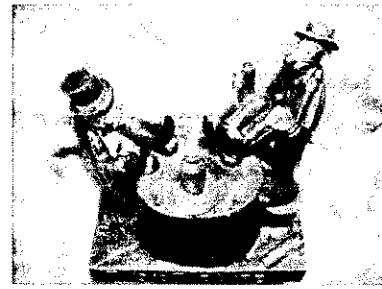

The second one is also an early Striker Table Lighter. It is well detailed and it depicts a stogie smoking Hobo. It is an unmarked piece. One has to wonder

if this piece was the inspiration to the ever-popular Reveler that Zippo immortalized in the early 1930's. It is a large and heavy lighter, standing near 7 inches and weighs almost 2 pounds.



Finally, we come to the last of the trio. It is a German Striker Lighter and originally I thought that it was made for the 1936 Olympics held in Berlin. I corresponded with

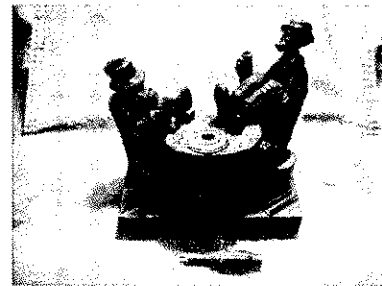

the well-known German lighter collector Gunter Broesan (Gunter passed away last Year and we lost a wonderful and knowledgeable person!) and asked him

if he had any knowledge of this piece. He informed me that it was not made for the 1936 Olympics. If a lighter were made for the Nazi-Olympics, they would have made it to look like strong and powerful young men with another type of torch. This lighter showing a middle aged costumed dwarf, holding a torch depicted some mining activity. Kids or small other men was used in the mines to light the torches of other miners and to illuminate the dark mineshafts. What a noble profession! As the picture shows, it is a very large lighter, standing over 9 inches tall.

I must admit, that this lighter is only a fond memory for me. I picked up the lighter a few years ago, on one of my trips to the Pacific North West. On my way home to our Winter Hideaway in Southern Arizona, I stopped to see a dear friend and avid lighter collector in the Palm Springs area. I enthusiastically showed him this lighter, and needless to say, I did not make it home with it. John, enjoy your great lighter.

Happy lighter hunting to all. - George

I Have Never Seen This Lighter..... Have You?

By: Art Brooks

On September 23rd, 1938 Belle C. Harris applied for a patent as a Ring-Lighter. The object of Belle's invention was to provide a fluid and wick cigarette lighter combined in a novel finger ring or bracelet. A second purpose of the patent was to provide a novel method of carrying fuel for the lighter and a heat insulation method to prevent burning the finger of the wearer. Belle addressed the fluid issue by making the ring hollow and inserting the wick into the hollow space. The "finger on fire" issue was addressed by the preferred method of placing a sheet of ASBESTOS under the flame carrying part. Asbestos was preferred because it has a low heat conductivity of about 0.0004 and is also non-flammable. It was stated as an alternative you could make the body of the ring from material having poor heat conducting properties.

Fig. 1.

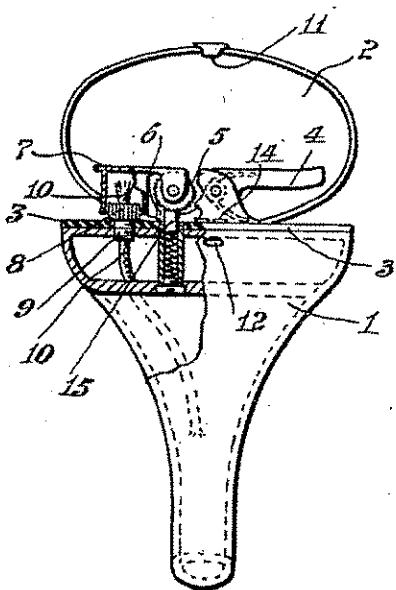

Fig. 2.

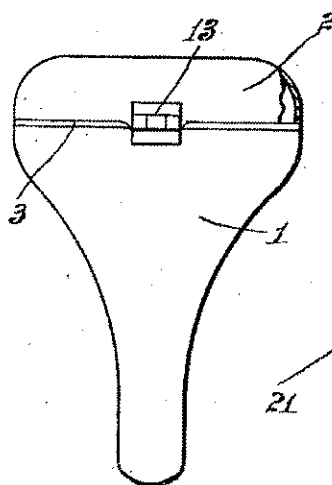

Fig. 3.

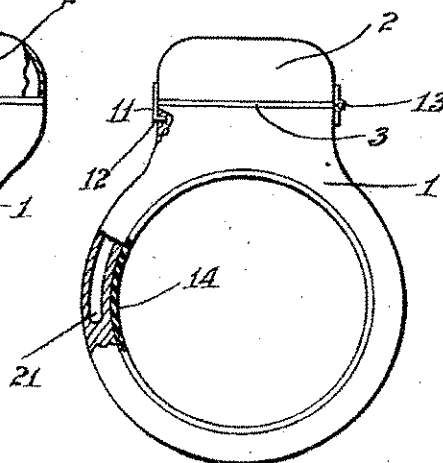

Fig. 4.

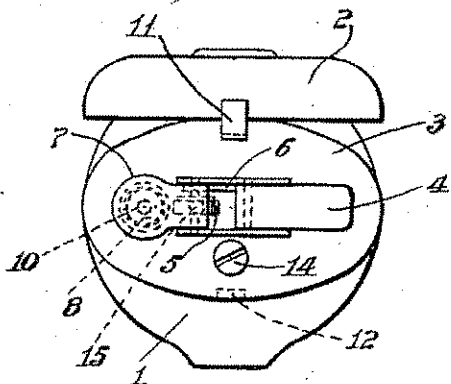
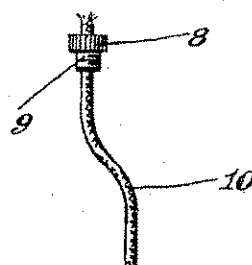

Fig. 5.



As shown in the patent, the ring is hollow with an enlarged bezel to insert the lighter mechanism. The lighter mechanism is the flip lever design that is unusual for this type of ring design. The ring has a hinged cover that protects the lighter mechanism. The opposite side has a snap that engages into a slot to hold it closed. This cover also improves the appearance of the lighter.

Belle Harris was granted the patent on May 20, 1941. On a personal note; I Have Never Seen This Lighter..... Have You? Please send your comments or questions to caymus99@sbcglobal.net.

CLASSIFIED ADS

FOR SALE OR TRADE

I have the following convention lighters for sale: 2012 – 36; 2011 – 8; 2007 – 2, 2006 – 18, and 1998 – 1. Please let me know if you are interested in any of these lighters. Tom Jones email <tdjones@advertisnet.com or call (573)345-4241

Back issues of the OTLS newsletter are available. Issues from 1984 thru 2000 are \$2.00 each plus postage. Articles from 2001 to the present are \$3.00 each. All proceeds go to the club general fund. Most are brand new and not copies and there are some fantastic articles/pictures. Contact Greg Ryman at GregRyman872@msn.com or (909)593-4413

Wands for most Ronson Touch-Tip & Table Striker Lighters. Also wands for Austrian Striker Lighters. New & exact dimensions. Professionally made by a Machine Shop. Color mated to your lighter to please the most discriminating collector. Available for \$30.00 + \$3.00 shipping. Call George Gynes (OTLS Member) toll free at 1-800-379-3415 or email gamma2002@gmail.com

Selling collection of lighters for my father. Watch lighter, Evans, Zippos, Scriptos, Novelty, etc. Email Teri at tab73156@hotmail.com for list. Buy all at discount. Collection includes 80 plus lighters. (this is a non-member, paid ad)

OTLS Convention Lighters 1991 – 2011, asking \$1000 for all. All MIB w/seals. OBO; 70th Anniversary Lighter in box w/seal \$70; Commemorative 1932 LA, NY, Paris, London, Tokyo in box \$50; 1997 Zippo car & 1998 Zippo Car Limited Collectors Edition lighter MIB with book & Zippo key Chair \$140 (all together); Gold Plated 1921 copy of Ronson Banjo MIB \$120; Zippo Operation Enduring Freedom, limited edition, MIB 24 K gold inlay of each of the armed forces, individually numbered \$120. John & Audrey Kroner email with questions alekro@yahoo.com or call (360)305-9811 (west coast time). FOR SALE: 137 piece Zippo Table Lighter Collector, 134 Zippo Rule Collection. Please contact Joe Speirs. \

FOR SALE OR TRADE

ZIPPO SAVINGS ARE ALIVE & WELL AT THE STUDIO

Exclusively for OTLS Members: save 20% on all in-stock Zippo® catalog, discontinued and new releases. Includes BLU® Outdoor Line, limited editions, MPL®, motorsports, accessories, Zippo® Heritage Series, combination gift sets & more. Use coupon Code **OTLS** at <http://StudioShowroom.com/zippo/> or mention OTLS/Judith Sanders when calling toll-free 888-437-8834.

FOR SALE by Tom Prylinski Ronson “Bogey” excellent condition \$400.00 Email pyrotjp@velocity.net

jspeirs@fidnet.com or call (580)284-4019

I can repair Zippo Cam Springs. Also repair Trench Art lighters. Email pyrotjp@velocity.net or write to Tom Prylinski

WANTED:

Looking for the Zippo 4 piece set of Tucker Cars. Clayton Vecellio (814)368-5294

Wanted: I am always looking for a couple of Ronson Whirlwind or Adonis lighters in mint condition with light brown enameled sides, and no engraving on them. The color I like best is a sort of butterscotch color. I am also seeking one or two Orlik Sport lighters in mint condition. Michael Stein jasmineandmike@aol.com (See May New Member Page)

WANTED (Unused) - OTLS 1988 Zippo lighter and/or Barrett-Smythe Alligator Snapping Turtle. Michael Maratea mmaratea@comcast.net or call (281)203-5051

I have a lot of lighters that are either slightly broken, or are lower end lighters which could be used for parts. If anyone wants a box of lighters and will pay me postage I will send you a box. There are also a few good lighters in this bunch that just aren't in the categories I collect now. In particular there are several of the silver (pot metal) MIOJ Table Lighters – these are in good shape. Please call or email Judith otls@suddenlink.net or call (903) 763-2795

WANTED:

WANTED: Unusual European Pocket Lighters, especially from some of the smaller European countries, such as a KABA (1933) or a French MOUCHON LE SPHINX. Call or email Judith Sanders OTLS@suddenlink.net or (903)763-2795

Wanted: Lighters with a mini liquor bottle encased in lucite. These are the ones I have: Glenlivet, Seagram's, Galliano, Gordon Gin, Chivas Regal, Prunelle, Nikka Whiskey, Smirnoff, Johnnie Walker. If you have any other than these, please contact me for sale or trade. Also seeking wooden carved figures with the Imco Triplex lighter inside. Scripto lighters with dates on the image inside. Thanks Guy Nishida btrade@ca.rr.com or call (310)804-4899

Wanted: MIOJ novelty fan lighter. Must be in working order. Contact Greg Ryman. Email me gregryman872@msn.com or call (909)593-4413

Wanted: Enameled Ronson and Evans Atomizers in excellent to mint condition. Please contact Richard Weinstein by email with photos at info@vintagelighters.com.

I want to sell some of my lighter collection of table lighters and pocket lighters. Please call John Krenzela at 724-228-3278

For Sale or Trade: Bryant & May Museum Catalog with the Supplement. Both in excellent condition. Contact Guy at btrade@ca.rr.com or call (310)803-4899

I would like buy a Viet Nam Zippo – either the “real” ones or the “fake” ones for a friend. He is not a lighter collector so doesn't care if it is real. Judith Sanders otls@suddenlink.net or (903)763-2795



Ruby Lane

Shop . Sell . Relax
Antiques & Art
Vintage Collectibles
Jewelry

Rare Possessions
Cliff Rispoli

P.O. Box 238523, Port Orange, FL 32123-8523
tel: 386.682.3161
crisp3861@aol.com
www.rubylane.com/shops/rarepossessions

IN MEMORY
OF
PAUL GIFFORD

Paul's daughter & son in law contacted us to tell me Paul had suddenly passed away. Paul has been a member of OTLS since the beginning of 1998. He has been to a few conventions, a couple of Zippo Swap Meets, and has met many of you.

Paul lived in Hollis NH, which isn't far from Leo & Dot Turini's house. He also lived close to Ken Southard (former member) and was friends with all of the NH members. I got to see Paul once while I was at Leo & Dot's house. He collected lighters for many years and loved to go to flea markets. Although he started with Zippos, he also collected all kinds of lighters.

He also had a couple of side collections - one of slide rules and one of cribbage boards. His ultimate passion however, was softball. He was a pitcher for 40 years.

He had 7 children and 13 grandchildren. His daughter Karen & her husband Dana live in Marblehead MA, which is fairly close to where Paul lived. Karen said when she decides to sell the lighters she will be in touch with OTLS. Karen also told me Paul's two favorite lighters were the Zippo with a Scottie Dog and a Zippo from the USS Thresher.

IN MEMORY
OF
RUTH RUNGE

Dot Turini called to let me know her dear friend, and mine, Ruth Runge, had passed away recently.

Many of you may not have known Ruth, but she lived in the same New Hampshire town where Leo & Dot live. Originally her husband, John, joined our club in 1991. After John passed away, Ruth stayed in the club and kept John's collection.

A lot of times when I would call Dot, she would say 'Ruth is here' so I would get to talk to Ruth also. And on some of my East coast trips, I would go stay at Leo & Dot's house. Dot would invite Ruth and others over to her house while I was there.

One year Ruth came to our Las Vegas convention and ended up working all weekend helping me with the convention.

Ruth has two grown children, a son and a daughter. Also some grandchildren. The family said they will be keeping the collection.

NEWS FROM AROUND THE WORLD....



John Heyde went to the Pen Show in Washington DC - also got to see Claudio Mazzi who was displaying his beautiful artwork at this show. Claudio paints on pens as well as Zippo lighters! Cecil Sweatt is doing much better after his surgery. Hal McKay came for a visit with Judith - and of course took some lighters home!

COMING ATTRACTIONS:

PLPG FALL LIGHTER FESTIVAL

OCT. 5 & 6

CALL PEGGY FOR INFO

636.940-0245

NEXT ISSUE November 2012.
SEND ADS BY September 20, 2012.



On The LIGHTER Side
International Lighter Collectors
Founders: John Cuevas
Judith Sanders

John Cornelius	President
Scott Beehler	Vice Pres.
Rich Weinstein	Editor
Judith Sanders	Secretary
Ira Pilosof	Historian
Karen Politi	Social Sec
Tom Jones	Conv. Lighter Chrm
Neal Duncan	Web Master

Board of Directors: Richard Ball, Rob Giarretta, Guy Nishida, Judith Sanders, Richard Weinstein, John Cornelius

ALL ARTICLES & PHOTOS USED IN ANY NEWSLETTER ARE PROPERTY OF JUDITH SANDERS AND "ON THE LIGHTER SIDE" AND MAY NOT BE REPRODUCED WITHOUT PERMISSION. OTLS IS NOT RESPONSIBLE FOR NEGOTIATIONS IN TRADING THROUGH CLASSIFIED ADS. FOR INFORMATION, CALL OR WRITE:

JUDITH SANDERS
P O BOX 1733
QUITMAN TX 75783-1733
U.S.A.
PHONE: (903)763-2795
WEB PAGE: <http://www.otls.com>