

ON THE LIGHTER Side

March 15, 1991

Vol. VIII, No. 2

ETC., Etc., etc.

The size of the newsletter has been increased this month to accommodate information about the 1991 convention.

Your Editor has ordered the 1991 Convention Lighters. Please place your order NOW. This year Leo & Dot Turini, Executive Board Members, have volunteered to handle this responsibility. Please send your order/money DIRECT to them. **DO NOT ORDER THROUGH YOUR OTLS OFFICE.** Only 1 lighter per member at this time - after all members have had an opportunity to order, then the club will make available to the membership any remaining lighters. The cost for this year's lighter is \$12.50 (which covers lighter, mailing envelope & postage). Overseas members please add \$2.85 to your order. (see photo on page 2)

In Nov. and Jan. the OTLS Office has received newsletters back with notes from the Post Office stating the labels were 'torn off by mistake'! To date I have only heard from 2 members. Any of you who did not receive your Nov. or Jan. issue please advise your Editor.

Greg Ryman has volunteered to become "SOCIAL SECRETARY". He is going to send cards to OTLS Members when they are sick, getting married, having kids, or for special needs. This will be appreciated by all of us - so when you know of events & needs, please let Greg know.

IMPORTANT! 4 members have advised they have been contacted by dealers/individuals outside the club because these individuals had a copy of our membership roster. The 4 members have asked that you **PLEASE DO NOT GIVE OUT MEMBERSHIP ROSTERS TO NON-MEMBERS!** **OUR MEMBERSHIP ROSTERS ARE FOR THE BENEFIT OF OTLS MEMBERS ONLY!**

DON'T FORGET THE LOGO CONTEST!
If you have questions, call!

IN THE SPOTLIGHT

ONE OF THE YOUNGEST!

If you are browsing through flea markets in Illinois, you may run into one of the youngest members of OTLS -- Justin Rickles.

In a recent interview, Justin admitted he is now 10 years old. A whole year older than when he first joined OTLS!

Justin went on to say he lives with his Mom and Dad, David and Veronica, and two older brothers, Brent (17) and Ben (14). They live thirty miles west of Chicago, in Naperville, Illinois.

When asked why he started collecting lighters, Justin responded "I just like them." He added "I collect a little of everything, but I like Zippo best!"

Finding Antique Shops and Flea Markets to explore take up all of Justin's spare time -- when he isn't going through his collection!

Justin feels very lucky to have met our own Jim Gartner one day at a flea market. He said Jim showed him how to remove flints, how to keep track of his lighters on index cards and generally encouraged him to keep on collecting lighters.

This collection runs from a Scripto with dice in the bottom to an Occupied Japan table lighter, shaped like a small canister and dated 1940. He has one silver lighter he describes as looking like an oil can. He also mentioned a match striker type with an Ace of Clubs, and a silver metal Aladdin's Lamp. And, of course, since he likes Zippos he has "a few of them."

It is inspiring to see this young man's interest in lighters, and to know he will be one of the members who will help carry on our interest in lighters in the years to come.

Keep up the good work Justin!

FROM THE PEN OF.....
....Judith Sanders

OTLS offers THANK YOU to the following members:

**** PEARL BAKER ****

For her time and talent in designing the 1991 Convention lighters (see xerox below)!

**** PERRY GROVER ****

For sending out so many applications to customers, who have become OTLS Members!

**** ZIPPO MANUFACTURING ****

For the wonderful publicity in the new Zippo Guide, which in turn has brought so many new members!

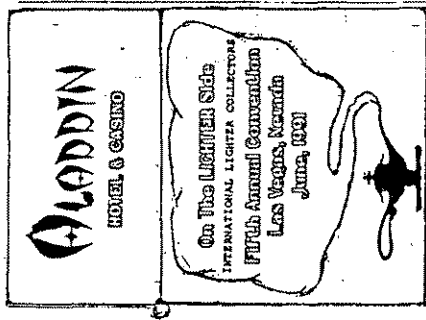

(COLORS: Red Letters, Gold Lamp & White Cloud)

A WORD FROM OUR PRESIDENT...
....PETER CAVANAUGH

Look what you started back in 1984 Judith! You've brought a lot of happiness and wonderful times to many people...bless you.

What an honor and thrill for me to be chosen as OTLS's 7th President. Maybe the Executive Board was just feeling sorry 'cause I'm an Aussie from Down Under!

By the way..did you know that America is the reason we Australians exist? You see, after your War of Independence Britain said, "Where in the world can we jolly well send our convicts now?" "Send them to Orstralia, old boy!" "Splendid idea old chap, spiffing suggestion!"

And so it came to pass. Australians and Americans are now close cousins, well liked in each other's countries.

Right from when I joined the club in 1986 (the year of John Cuevas' Presidency I'm pleased to note) I've been made to feel so welcome and have not missed a con-

vention. I'd make it even if I had to swim the Pacific!

I've noticed that each convention gets bigger and better than the last. The Aladdin in Las Vegas last June was terrific! The perfect place for our get-together, in fact so much so, we will all be back again this June.

Will you be there? I hope so as you'll make a lot of new friends; also you will see more lighters in the 3 days of selling and trading than you'll most likely see all year. I got so many last year that when I arrived back in Australia the Customs guy said "Anything to declare?" I said "Yeah, bankruptcy!"

This year I'll spend another \$1800 on air fares but I'll be there.

Many thanks to those members who have answered letters I have sent. It's so disappointing after writing to a fellow member not to receive a reply, even a postcard back would be better than nothing.

Well, 3 months to go and I'll again say hello to Ad from Holland, Richard from England together with all those who enjoyed themselves last year and the members coming for the first time.

May I take this opportunity of extending warm greetings to all OTLSiders for a happy, healthy 1991.

Good Collecting!

.....Terry & Karen Cairo

We were fortunate enough to meet the grandson and namesake of the inventor, Mathew Spinello. Mr. Spinello has been searching for one of his Grandfather's lighters for several years and has not been able to locate one. He is not a lighter collector, but would very much like to find this lighter to keep in the family archives and pass it along to his children.

If you have questions, please give us a call. (See reduced photo below showing Spinello Cigar Lighter)

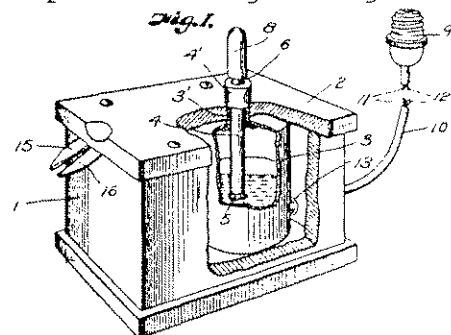

....Boris Rubin

Recently I had a great opportunity to visit the LIGHTER MUSEUM HOLLAND and spent a week with Ad Van Weert. (I needed at least a month more to go through all the interesting things and materials. Hopefully next time I can stay much longer). And I think it is my duty as a collector and a member of OTLS to report on it.

After Ad picked me up at the Amsterdam Airport, he brought me to his very charming and homey house. There I met another great person, his wife Alice. Alice is also a member of the Board of Directors of the museum and she does a lot for the museum's growth. After a short breakfast we went to the museum.

Very briefly (because it is impossible to describe everything in only one letter) about the museum. Step by step: Every lighter that needs repairing goes to the Museum's Repair Department. There each lighter receives the best treatment with full respect, without any exceptions. Ad cleans them, restores them if necessary. He receives a lot of help with this process from a wonderful man named Gerard.

Then all the information about the lighter goes into the computer, which is operated by a very interesting man, whose name is Jan. For this purpose he uses a very difficult program which was designed by another one of Ad's friends - Nico.

The final step is to place the lighter on one of the hundreds of shelves in the closed showcases. (One tiny detail: you cannot touch the lighters without putting on special gloves).

Of course it is absolutely not necessary to display all of the lighters (the museum has around 14,000 lighters). Using a few thousand lighters, the exhibition is designed to show the history and development of the lighter. In another room of the museum there are a lot of boxes with very

carefully packed lighters inside, waiting their turn to be taken care of.

Also in the museum I saw the equipment and machinery used years ago for making lighters. Something that really impressed me was the huge amount of rare documents and printing materials which Ad Van Weert uses in his research process. It took years of preparation. Finally and fortunately Ad Van Weert has started to write his book. I was lucky enough to be able to see the prototype of his book. One thing I have to say: This is going to be the book I have been waiting for a long, long time. Ad is planning to release his book in the very near future, and I hope everything works out alright.

(Editor's Note: Boris has sent some excellent photos from his trip, which will be added to the OTLS Scrapbook)

#####

THE FLINT

by Charles Arrundale

The small piece of metal commonly known as the flint, without which the lighters we know and cherish would not have come into being. The word metal may seem strange, but its scientific name is "Auermetal," so called after the famous Austrian scientist and inventor, Dr. Carl Auer Von Welsbach. It is a misguided assumption, because it is called a flint, that it is manufactured from ground and reconstituted natural flintstone, which our ancestors first used for making fire. But nothing could be further from the truth.

At the beginning of this century, Dr. Welsbach, while experimenting with rare earths, discovered that cerium, although it had no pyrophoric qualities, it could, when made into an alloy with iron, create a spark with enough power to ignite gas. After many years of experimenting to finalize the correct ratio of components into producing a revolutionary, and economically viable flint stone, he patented it

(continued on page 4)

THE Flint continued

1910. He then founded the Treibacher Chemische Werkes, in Austria to manufacture his invention.

Many companies throughout the World have been allowed to produce the flint on a license basis, in accordance with the patent right of Dr. Welsbach's invention. Since its' discovery, the composition of the flint has remained unchanged, because up to the present day, it is the only known flint alloy that can produce enough phrophoric quality to ignite gas and petrol.

It is sad that the new fangled electronic ignition is replacing the humble flint, and gas has replaced petrol. With the short life expectancy of this new breed of lighters, they don't appear to have a soul.

#####

UPDATE: THE RONSON BOOK

Metamorphsis is probably the most apt description now. The original plan (not related to original sin) was that Lynn & Urban would publish about 2,000 copies of the book themselves. By Fall of 1990 it became obvious that with over 500 discrete wick models identified and a reasonable amount of company history included the book would be gargantuan and the cost completely out of reach for the two of us.

On to Plan 2: Why not do it in a number of smaller volumes? The feedback from a number of our (unpaid) advisors was that probably wouldn't be successful, again assuming we could find 2,000 buyers. On to...

Plan 3: Find a publisher. Not something we wanted to do. So far we've found one publisher (of collectable items) that has shown an interest. The hitch is they don't want a Ronson only book. "Include the other American lighters" they say.

So for the moment, we're still contacting likely publishers hoping to find one with the

foresight to do the kind of book we want. It doesn't look encouraging, but we are not giving up.

One idea suggested was to pre-sell the book. Get \$\$ up front to fund the printing and binding costs. Any ideas out there?

We encourage your comments and suggestions. Get in touch with Lynn or Urban. We need all the help we can get.

(submitted by Urban Cummings
& Lynn Baker)

#####

In the middle of editing the March paper, a phone call was received from Robert Hefley of Tulsa, Okla. He said he thought he would come to see my collection -- and go to Canton!

Canton, Tx. has one of the largest Flea Markets in the Southwest one weekend a month. Dealers from many different states show up for this event.

Robert and I left about 8:00 A.M. to go to the flea market. We stayed most of the day and then hit a few antique stores on the way back.

By the time we got home my friend Anne, from Dalles, arrived. So we went out to eat, went home and started looking through lighters.

Robert only brought a small case of a few of his 'choice' lighters to show me. But those few he brought were enough to cause me to turn BRIGHT GREEN - some wonderful Trench Art, an original Colibri, a Ronson Watch lighter he had just acquired, just to name a few! The Ronson Watch Lighter was absolutely exquisite - and I had never seen one before.

On Sunday we all went to Gladewater, Tx., which is a small town east of Quitman. Gladewater is called the "Antique Capital of East Texas". Unfortunately we didn't find anything real exciting, but had fun anyway!

It was a real pleasure to have Robert visit the OTLS Office; and to have the opportunity to meet him. Although I realized after he had left I really missed my chance to interview him for one of the newsletters - but I will catch up with him sooner or later!

Guess I should try going north of the Red River!

As we go to press, John Beckwith is completing a new brochure with more BECKWITH lighters, which will be for sale. For new members, John was the inventor and owner of Beckwith Lighters in the '50's, presently living in California. There are approximately 72 lighters in this brochure. These are 'overruns', extra lighters and generally left from the stock of his company. All of these particular lighters are the round, 'full cover' type - the round lighters being his specialty. For a copy of the brochure, send SASE (50¢) to John. See photos below of some of the lighters which will be available. IF YOU DO NOT HAVE A BECKWITH IN YOUR COLLECTION IT IS A "MUST HAVE"!

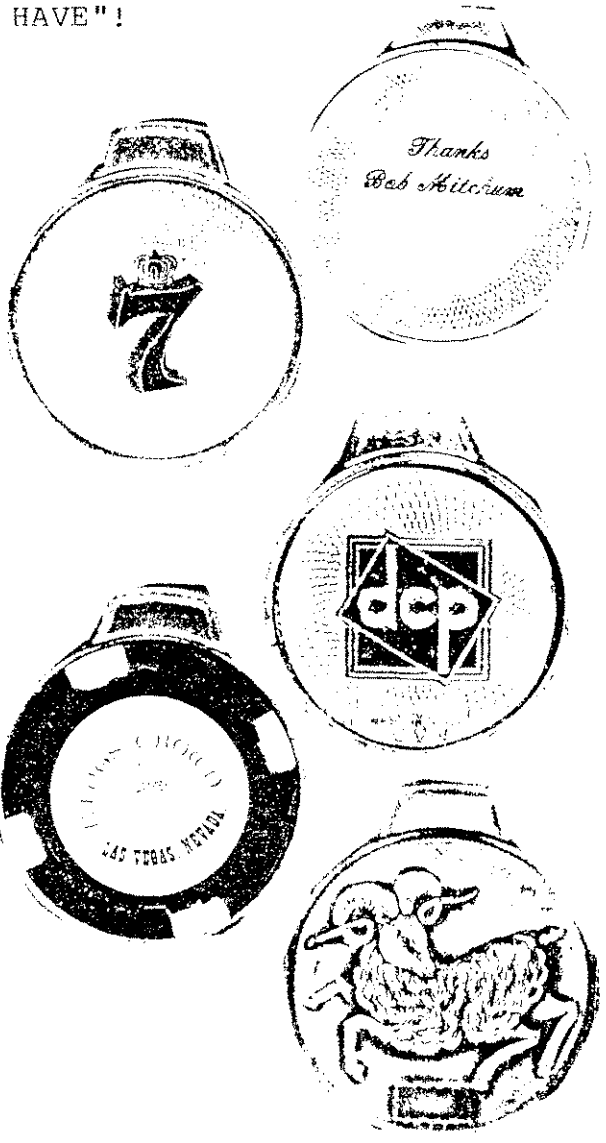

WELCOME NEW MEMBERS!

1. John E. Tegethoff, Jr.
20 Chaminade Dr.
Creve Coeur, MO 63141
314/432-8176
Ronson/Trench Art
 2. Gretchen Voeks
2355A Menard St.
St. Louis, MO 63104
314/776-2561
Novelty
 3. Geoffrey D. Andrews
27 Tunah St. Howrah
Tasmania AUSTRALIA
002/479052
Zippos/Military, etc.
 4. Tom Oyen
913 Harris
Bellingham, WA 98225
206/676-8585
Novelty/General
 5. Kelly Hasselback
7550 Brick Hyway
Vermontville, MI 49096
517/543-2710
MIQJ/Gas/Auto
 6. Jon Gibbs
30 East Lincoln St.
Verona, NJ 07044-1506
201/239-1026
General
 7. Dean Hodgdon
2930 East 77th St.
Tulsa, OK 74136
Lift Arms/General
 8. David F. Fitzgibbons
1300 Weathervane Lane
Suite 218
Akron, OH 44313
216/869-6001
General
 9. Darren J. Dwyer
4 Warwick St. Box Hill 3129
Victoria, AUSTRALIA
03/891-4728
Zippo & General
 10. Bob Vale
1356 N. Ave 46
Los Angeles, CA 90041
213/255-0879
Ronson/General
 11. Wendell Ratcliff
2712 Amber Dr. So.
Ft. Worth, TX 76133
Zippo
 12. Jerry D. Armstrong
206 Meridith Dr.
Beloit, WI 53511
608/364-4678
Old & Unusual
 13. Tim S. Belden
104 - 6th St., S.W.
Canton, OH 44702
General
- ADDRESS CORRECTIONS:
1. Joe Roseman
P. O. Box 618
Idyllwild, CA 92349
714/659-5344
 2. Sue Kane
3952 Southwestern Blvd.
Orchard Park, NY 14129
 3. Guy Nishida
7429 Ogelsby Ave.
L.A., CA 90045
Same Tel: 213/215-1951
(Moving 3/25/91)
 4. Terry & Karen Cairo
City is ADDISON
 5. Frank Gunderson -
Apt. U 11
 15. Nelson Hoffman
600 E. Chester St. Bypass
Kingston, NY 12401
Early, to '30's
 16. Duane James
Box G
Grant City, MO 64456
816/564-3367
General
 17. Michael H. Katz
14 Berkeley St.
Watertown, MA 02172
617-924-9287
Old P/Ls
 18. Richard Sutton
1997 Manchester Rd.
Akron, OH 44314
216/645-1261
Ronson
 19. Howard J. Hopkins
13789 Martinique Dr.
Seminole, FL 34646
813/595-1491
General/Novelty
 20. Jurg Schmutz
Thiersteinerrain 15
4053 Basel SWITZERLAND
Zippo
 21. James Smith
2713 W. 12th Pl.
Yuma, AZ 85364
602/329-0384
General/Cig. Cases
 22. Glen Fitzgibbons
4 Martin Drive
Assonet, MA 02702
508/644-5610
Evans & Ronson
 23. Randy Stoeckmann
7940 S. Wildwood Dr. #7
Oak Creek, WI 53154
414/764-5658
General
 24. Bob Martin
Rt. 1, Box 245
Bahama, NC 27503
919/471-8845
General/Figurals
 25. Raymond Phillips
45-B Ivy Circle
Trooper, PA 19403
??/539-8673
General
 26. Pete & Donna Conley
Rt. 2, Box 701
Warrensburg, MO 64093
Novelty/General
 27. Clement E. Marks, Jr.
110 Bleeker St., Apt. 21D
New York, NY 10012
Dunhill/Cartier/Exotics
 28. Ann Mills
1451 E. McFadden Ave.
Santa Ana, CA 92705
714/547-8796
General/Novelty
 29. Terence Koch
P. O. Box 128
Los Altos, CA 94022
Fountain Pins
 30. Keith G. Riley
Rt. 1, Box 9H4
Marion, ARK 72364
501/739-3005
General
 31. Wilbur L. (Bill) Pichard
14817 Perrywood Dr.
Burtonsville, MD 20866
301/384-4126
General

(continued on page 9)

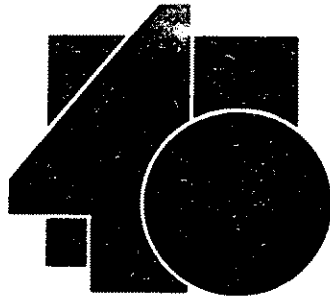

Theatre Forty

P R E S E N T S

The Lights of My Life

a One Man Show

written & performed by

David
Hunt
Stafford

directed by

Darlene
Baker

An Artemus Production

8:00pm

Mon - Tues - Wed

Mar. 25, 26, 27

Apr. 1, 2, 3

Apr. 8, 9, 10

Apr. 15, 16, 17

FOR RESERVATIONS
THEATIX

(213) 466-1767

TUES.-SUN. 11:00-7:00

Closed Mondays

Charge Cards Accepted

Group Rates (818) 995-4421

TICKET PRICES

General Public	\$10.00
AEA, SAG, Aftra Members	\$ 5.00
Theatre 40 Subscribers	\$ 3.00

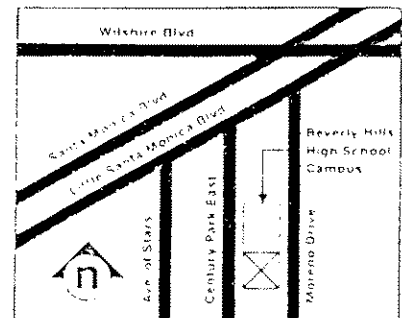

241 Moreno Drive Beverly Hills FREE INDOOR PARKING

Authorized Repair Service

30 WEST 57th STREET
NEW YORK, N.Y. 10019

(212) 586-0947
Fax (212) 586-1296

SPECIALIZING IN THE REPAIRING OF VINTAGE AND MODERN
CIGARETTE LIGHTERS FROM MANUFACTURERS THE WORLD OVER.

DUNHILL ■ DUPONT ■ RONSON ■ EVANS ■ TIFFANY ■ CARTIER ■ ZAIMA
ROWENTA ■ BRAUN ■ CONSUL ■ MARIMAN ■ RIVO ■ THORENS ■ PRINCE
KW ■ NEGBAUR ■ MYLFLAM ■ ASPREY ■ MARATHON ■ ALADDIN ■ GIANT
KREISLER ■ ASR ■ ROYAL CASE ■ RAYNO ■ BETE JET ■ PARKER ■
COLIBRI ■ CHRISTIAN DIOR

Official U.S. Agents for:
ALFRED DUNHILL
S. T. DUPONT
WATERMAN PEN CO.

AUTHORIZED REPAIR SERVICE IS ALSO A WORLD RENOWNED SERVICE CENTER FOR
VINTAGE FOUNTAIN PENS AND CARRIES AN EXTENSIVE SELECTION OF FOUNTAIN PENS
AND CIGARETTE LIGHTERS FOR SALE.

- ESTIMATES GIVEN ON ALL REPAIR REQUESTS
- WE PURCHASE VINTAGE FOUNTAIN PENS AND
CIGARETTE LIGHTERS

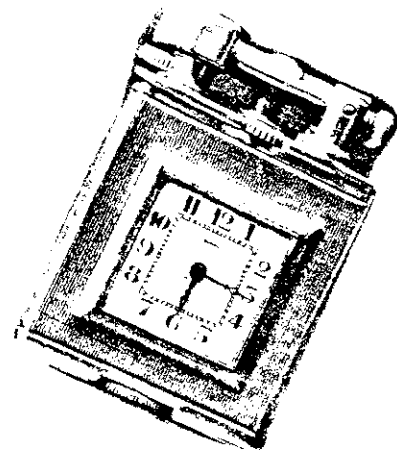
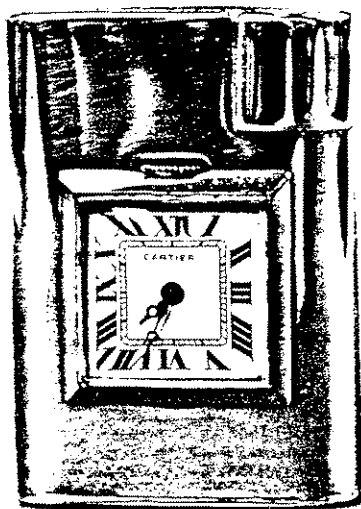
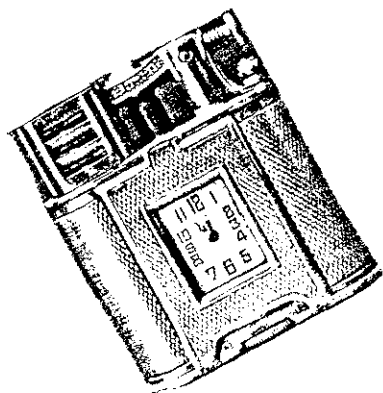

Ad Paid for By Authorized Repair Service

CLASSIFIED ADS

FOR SALE OR TRADE

A ZIPPO COLLECTION FOR SALE:
217 Advertising
132 Misc. (initials, plain, signatures)
4 Salesman's Sample Cases
4 Knives
A few keyrings
3 NEW (Square shape) display cases (Lighted & revolving)
Want to sell as 1 lot.

\$7500.00. Richard Rotman

I am selling approximately 50 Zippos for a man who formerly worked for Zippo, and whose Grandfather worked for Zippo and was a friend of George Blaisdell. Some of these will be priced & some on a mail auction. If you are interested in a complete listing, please send a stamped, self addressed envelope, marked "Zippo", to your Editor. Since this collection includes many older models, the mail auction will last 3 weeks so all overseas members also have an opportunity to bid! PLEASE BE ADVISED YOU MAY BID AS MANY TIMES AS YOU WANT. This collection includes 2 leather Zippos, lots of Pat. 203?????, some Prototype - never before seen, AND THATS JUST A SMALL PART. Judith Sanders

LET'S MAKE A DEAL! (from Guy Nishida) Have RONSON Melrose, Juno, Georgian, Diana, Newport, Cupid, Boat, Spartan, Fantasy, Minerva, Octeete (touch-tip) Waldorf, DoDo, Hound Dog, Sterling Adonis (in box), Sterling Jubilee, and others; OCCUPIED JAPAN - Camera, Telephone, Gas Pump, Pistol, Lantern w/tray; DUNHILL Sports Lighter, Pipe Lighter, Unique, Silent Flame Fan Dancer; NEGBAUER Cannon, Golf Bag; CARTIER Santos, FLAMINAIRE Crillon; KOOPMEN POCKET LAMP; CAPITAL; CLARK Firefly, POLO lift arm; Memory of Japan naughty lighter; KASCHIE T/L; EVANS case lighter (gold tone) & Art Deco Perfu-mist; IMCO Foxhole (in box), Safety (in box); REGENS (new); THORENS

FOR SALE OR TRADE

Porter; 3pc. LIMOGES; Hand-Painted THORENS set; LEKTROLITE: ZIPPO: Smelter Carpet Seller on Camel (striker); NOVELTY; ADVERTISING: GUMBALL lift arms; SASCHA B; early cigar lighter; German Lighter Book; Phillips Auction Catalog (England) of 12/5/90

Dunhill Dueling Pistol for trade for Ronson/ARW "Superba", Ronson/AMW Strike Lighter "Lion" or other unusual Strike lighters or Touch-Tip (Ronson/AMW only) plus hundreds of logo, novelty, Zippo, Evans, Bentley & Beatie Jets to trade for Ronson/AMW lighters. Lynn Baker

Dunhill Lacquered/Enameled & Gold (Gas) Lighter - Dunhill has issued a certificate stating current value is \$430 - also says Dunhill will not be making enamel/lacquer lighters anymore - too difficult. (OTLS has certificate & photos if interested). This lady will negotiate. Please write or call Mrs. Jay Rutherford, 1320 Augusta Ln S, St. Petersburg, FL 33707 (813/381-1945) (Non-Member) Please identify yourself as a Member of OTLS when calling.

Selling a small collection just acquired, plus ALL my own duplicates. There are advertising lighters, Military Zippos, MIOJ, Novelty & a few 'exotics' (that's the type advanced collectors buy!!) For a complete inventory, send SASE (with 50¢) to Judith Sanders
New Zippo lighters with Custom Imprinted Logos. For descriptions send SASE. CLASS PRODUCTS, Attn: Tom Carvellas 21213-B Hawthorne Blvd., Torrance, CA 90509

David Stafford says if you have questions about his show please call 213/666-5500 (see ad on page 6)

FOR SALE OR TRADE

What to sell CAMEL LIGHTER - (striker type) 10 different colors - EXCELLENT CONDITION. \$250 Colin Day

Ralph Fink has advised the museum listed below has a inscribed military insignia Zippo for sale by mail order. Send, for information to:
JFK Museum

P. O. Box 70060
Ft. Bragg, NC 28307-5000
(Thanks, Ralph!)

Dunhill Service Lighters - MINT IN BOX (3 COLORS) \$35 each; Silverplated (gas) by CHRISTIAN DIOR - I have 9 of these shown below. John Cuevas (reduced size photo)

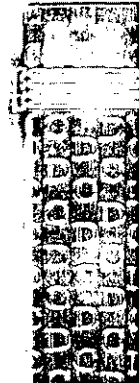

MINT IN THE BOX 100th Year Celebration of Civil War. (See photos below) Taking offers by mail. 1 is a "Howard" & 1 is "Rebelite".

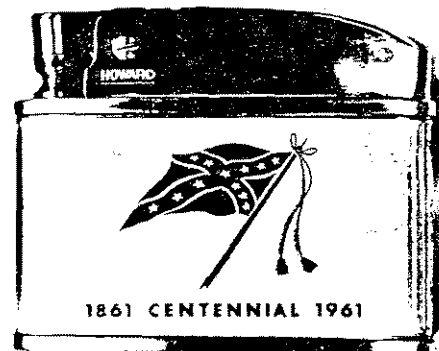

PLEASE SEND IN "WANTS" FOR A SPECIAL CONVENTION CLASSIFIED SECTION IN MAY ISSUE - THIS MEANS ANYTHING 'SPECIAL' YOU MIGHT WANT OR BE SELLING!

- 32. David E. DeBoer
132 Apple Farm Rd.
Red Bank, NJ 07701
General
 - 33. David Santana
130 Choctaw Circle
Chanhassen, MN 55317
612/937-8236
Ronson T/Ls
 - 34. Larry E. Asher
11350 Miller Rd.
Johnstown, OH 43031
614/967-7642
Zippo/General
 - 35. Arlene D. Cundiff
2107 S. Twilight Lane
Richmond, VA 23235-5477
804/674-9230
Ronson T/L/Zippo
 - 36. James L. Kastelle
11332 W. Puget Ave.
Peoria AZ 85345
General
 - 37. James Foskin III
1000 Lexington St., #32
Waltham, MA 02154
Zippo
 - 38. John D. Runge
Cutter Road
Temple, NH 03084
603/878-2690
General
- A BIG WELCOME FOR OUR MILITARY!!
- 39. Lcpl O'Neal T.R.
HQ 5/11 Supply
1st MAR DIV
FPO San Francisco, CA
96608-5523
(First Name: Tyrone)
 - 40. Raymond Cowsert
V-4 Division
USS Saratoga CV-60
FPO Miami, FL 34078-2740

OUR FACE IS RED!!!!
In the Jan. Roster the following members were accidentally dropped from the Roster - PLEASE PUT THEM BACK!

- 1. Roselyn Gerson
Box Letter S
Lynbrook, NY 11563
516/887-9349
- 2. Gasper Gilardi
119 Moss Lane
Waggaman, LA 70094
- 3. John Grawe
Box 126 Wauconda Rd.
Wauconda, IL 60084

PERSONAL NOTES:
Kevin Kelley, Jr. and his wife are 'expecting' - which means Kevin Kelley, Sr. is going to be a GRANDFATHER!

David Stafford has written if you have questions about his show, (see page 6), please call him at 213/666-5500

WANTED

U.S. Navy Lighter (Zippo) U.S.S. CONE (DD866). I will trade 3 other navy ship lighters for this one. I spent 8 years on. Please write or call. John Fiola

WANTED: Single Ronson "Puritan" or "Puritan" parlor set, Ronson "Waldorf" set & Ronson "Grandee". Joe Rosema
Want to buy or trade miniature lighters with other OTLS Members. David Poore
Wanted any Platinum lighter or Gold Novelty lighter. Richard Ball

Wanted: Zippo lighters of any sort, especially ones concerning American Sporting teams (College/Pro). Also coke bottle petrol lighter in good to excellent condition. Damian Smith

Wanted 2 ROUND Negbaur golf bags (not oval one); also Ronson "Bogey". Kevin Kelley
Looking for Zippos! Don't have enough to trade yet, but would like to buy your duplicate advertising/logo Zippos. Especially interested in music-oriented trademarks. Please write & let me know what you have? Michael Kolb

Wanted: Any very different, rare or old lighters, both in shape or in structure. The larger the better. Write & describe or photo. Chin Hsu

WANTED: Zippo or Zippo-style from late '60's with pic. of Peanut's cartoon character Snoopy lying on top of doghouse. Thought bubble above Snoopy says F----. Contact Matt Erulkar, 318 Kent Rd. Bala Cynwyd, PA 19004 (215/664-4554) (NON-MEMBER)

NEXT ISSUE MAY 15
PLEASE SUBMIT ADS BY
MAY 1 (EARLIER DEADLINE)

WANTED

Kevin and June (Jointly) are looking for "TOP OF THE LINE" Jeweled lighters - Cartier, Dunhill, Asbrey, Van Cleeve & Arpel, etc.) Please call KEVIN KELLEY (818/578-8554) or JUNE BERLINER (213/276-1431)

Addicted to Zippos - Looking for better condition '32 thru '40 Zippos, with or w/o advertising; also Town & Country, Leather covered & wrapped, & Black WWII. Have many nice Ronsons, Evans & some surprizes for trade. Call or write Terry & Karen Cairo (708/543-9120)

The "Lighter" Book, Ronson Bartender. Want to trade with OTLS Members. Bill Koppany (213/934-4225)

Wanted...plain used Zippos, good condition plain or patterned but no initials. Will trade several of them for something of more value in my collection of various petrol pocket lighters. Peter Cavanagh

Want to trade for War Ship Zippos - do you have any? Trevor Orr

On The LIGHTER Side, Inc. International Lighter Collectors	
Peter Cavanagh	President
Larry Tolkin	V.Pres.
Judith Sanders	Sec./Treas Editor
Greg Ryman	SocialSec
Lynn Baker	Historian
ALL ARTICLES & PHOTOS USED IN ANY NEWSLETTER ARE THE PROPERTY OF JUDITH SANDERS AND "ON THE LIGHTER SIDE" AND MAY NOT BE REPRODUCED WITHOUT PERMISSION. FOR INFORMATION, WRITE OR CALL Judith Sanders Rt. 3, 136 Circle Dr. Quitman, TX 75783 903/763-2795	